

NEW CONFIGURATION OF TRACTION CONVERTER WITH MEDIUM-FREQUENCY TRANSFORMER: PRIMARY PART

V. Blahník, Z. Peroutka, J. Molnár, J. Michalík

*Department of Electromechanical Engineering and Power Electronics, Faculty of Electrical Engineering, University of West Bohemia, Univerzitní 26, 30614 Plzeň, Czech Republic,
tel.: +420377634406, mail: lucke@kev.zcu.cz, peroutka@ieee.org, jmolnar@kev.zcu.cz, jmichali@kev.zcu.cz*

Summary This paper deals with new configuration of the traction converter with medium-frequency transformer intended for ac trolley wire fed locomotives. It is concerned to the primary serially connected single-phase voltage-source active rectifiers, which are directly connected to the trolley wire. This contribution presents the proposed control of the primary active rectifiers, simulation and experimental results of designed low-voltage laboratory prototype of converter of rated power of 12kW.

1. INTRODUCTION

This project has been made in cooperation with our industrial partner Škoda Plzeň company. The objective of this project has been the research into the prospective configurations of the ac trolley wire fed traction converter for the new generation of the locomotives and especially suburban units. The presented converter configuration with medium-frequency transformer is one of selected promising solutions. The explored converter consists of indirect frequency converters at its input. The input parts of the indirect converters are composed of voltage source active rectifiers, which are directly connected to the ac trolley wire. Therefore, they are connected in series – see Fig. 1. The medium-frequency transformer is fed by voltage source inverters operated in the six-step mode with the output frequency of 400 Hz. The voltage-source active rectifier (VSAR) at the secondary side of the medium-frequency transformer is fed by square wave voltage with frequency of 400 Hz and the control of this part was present in [1]. In the literature, there are published very interesting papers dealing with this new configuration of the traction converter for locomotives – e.g. [2] – [6].

This paper describes proposed control of the primary active rectifiers, presents simulation results as well as experimental evidence of designed laboratory prototype of loco converter of rated power of 12kW.

2. PROPOSED CONTROL STRATEGY OF PRIMARY SINGLE-PHASE VOLTAGE SOURCE ACTIVE RECTIFIERS

The proposed control strategy of the primary voltage-source active rectifiers is shown in the Fig. 2. We control the total dc-link voltage U_{cw} (it means the sum of dc-link voltages from all rectifiers). The dc-link voltage controller (solved as conventional PS controller) commands the angle ϵ between the trolley wire voltage and voltage at the rectifier ac side terminals (u_v). The magnitude of u_v is calculated from the information about the trolley

wire voltage magnitude (U_m) and commanded angle ϵ . Thus, we employ the conventional model-based control of input rectifiers. The PWM with shifted carriers is used for the control of primary voltage-source active rectifiers.

3. SIMULATION AND EXPERIMENTAL RESULTS OF DESIGNED LABORATORY PROTOTYPE OF PRIMARY SINGLE-PHASE VOLTAGE SOURCE ACTIVE RECTIFIERS

The proposed converter control has been implemented in fixed-point DSP Texas Instruments TMS320LF2812. The designed converter prototype has rated power of 12kW. The prototype consists of two converter cells at the primary side (in the laboratory, we employ the transformer with two primary windings). Fig. 3 – Fig. 8 present simulation and experimental results of the primary voltage-source active rectifiers in rectifier mode and in inverter mode respectively under steady-state conditions. The converter behaviour under transient conditions is documented in Fig. 9 – Fig. 12.

The proposed model-based control with PWM is simple and ensures very good converter behaviour under steady-state conditions as well as satisfactory dynamic properties. PWM is eligible from the viewpoint of low-frequency EMC disturbances – e.g. problems with railway signaling. The operated shifted carriers provide multi-level voltage on the converter ac terminals (in this case, the converter is five-level – see Fig. 7 and Fig. 8). The multilevel nature of the converter brings positive impact on design of input inductor L_{vst} . The disadvantage of presented control is the problem with efficient trolley current limitation, because trolley current is in this case controlled indirectly. The designed laboratory prototype of traction converter has been successfully tested in the whole power range. We have prepared in cooperation with our industrial partner Škoda Electric, a.s. a 100kW prototype, which is nowadays under the tests.

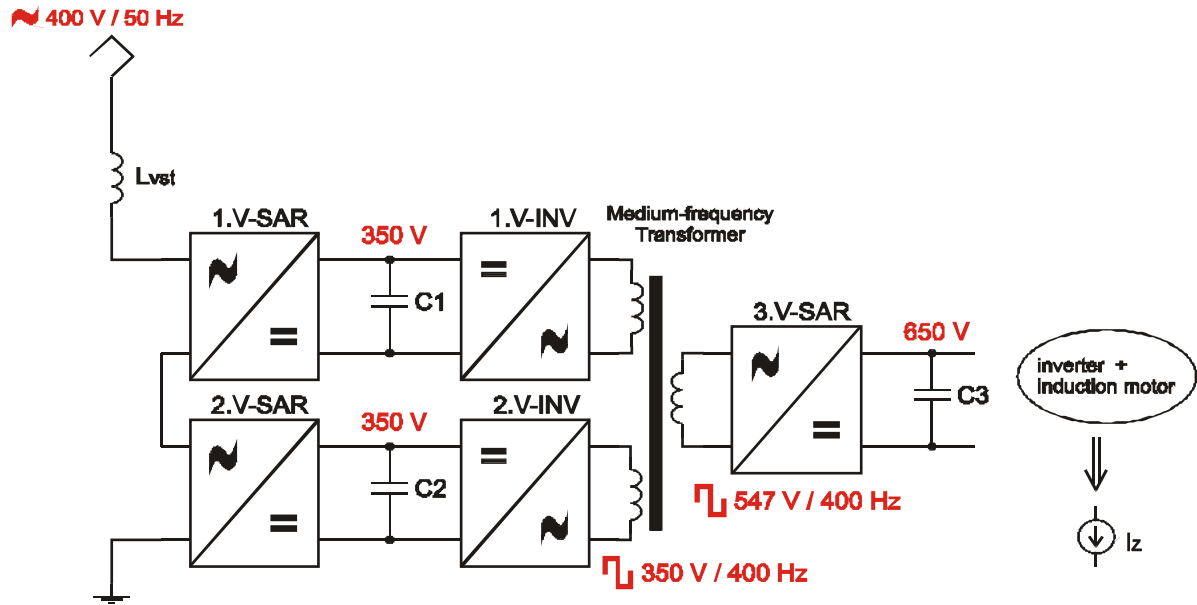

Fig. 1. Configuration of designed low-voltage laboratory prototype of traction converter with medium-frequency transformer

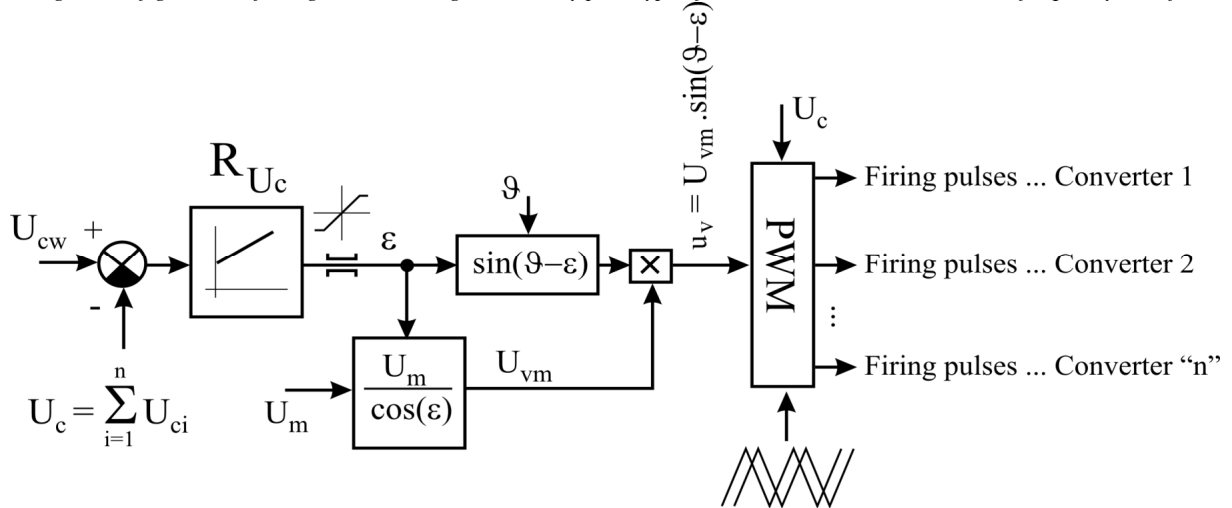

Fig. 2. Proposed control of primary voltage-source active rectifiers

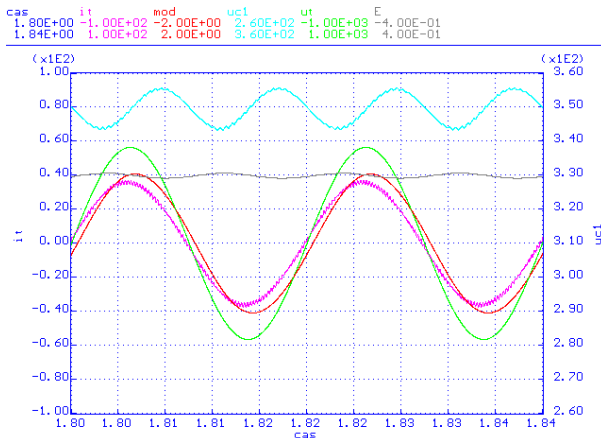

Fig. 3. Behaviour of primary voltage-source active rectifiers under steady-state conditions in rectifier mode (load ... $P = 10 \text{ kW}$)

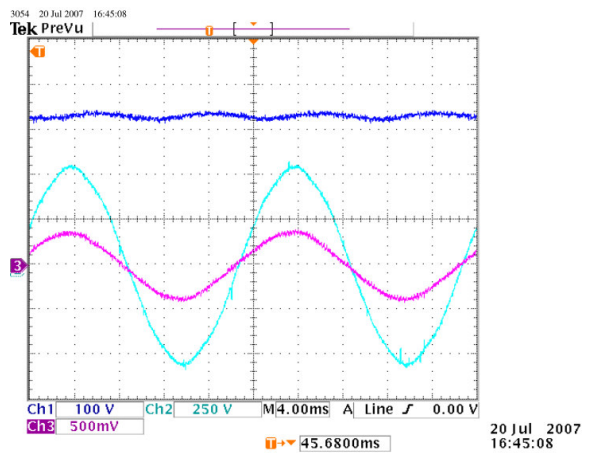

Fig. 4. Steady-state – rectifier mode (load ... $P = 6.5 \text{ kW}$):
ch1: Voltage U_{ci} , ch2: Trolley voltage U_b ,
ch3: Trolley current I_t (10mV/A)

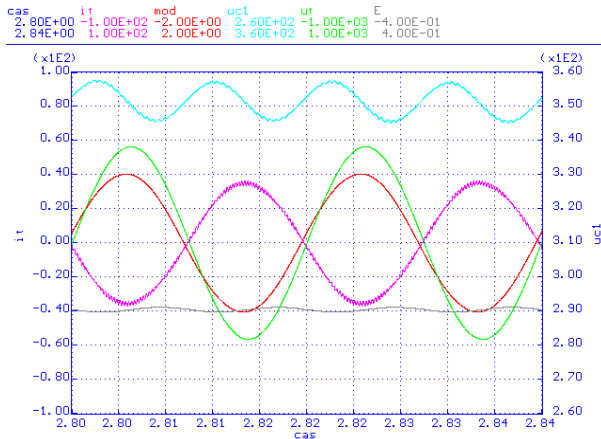

Fig. 5. Behaviour of primary voltage-source active rectifiers under steady-state conditions in inverter mode (load ... $P = -10$ kW)

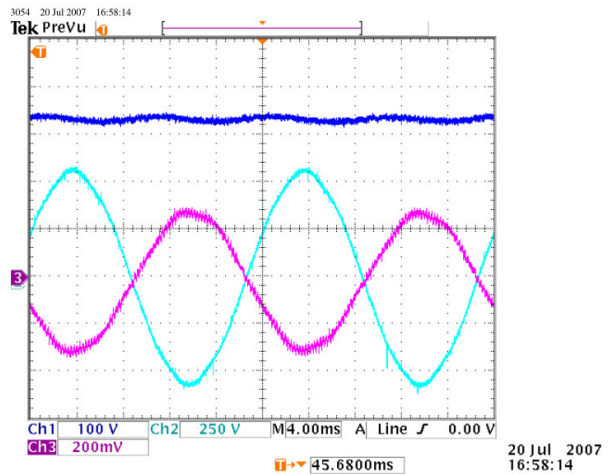

Fig. 6. Steady-state – inverter mode (load ... $P = -5.6$ kW): ch1: DC-link voltage U_{cl} , ch2: Trolley voltage U_b , ch3: Trolley current I_i (10mV/A)

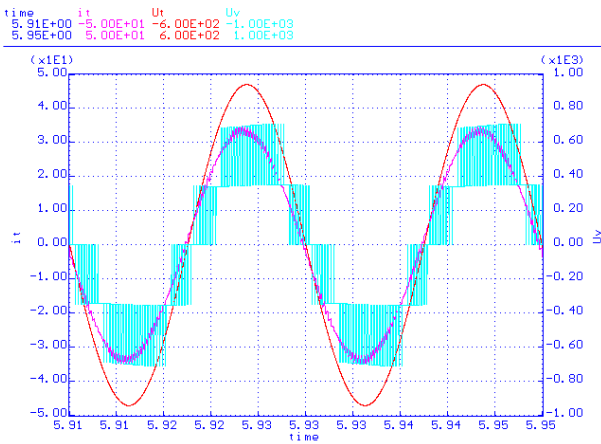

Fig. 7 Behaviour of primary voltage-source active rectifiers under steady-state conditions in rectifier mode (load ... $P = 9.3$ kW)

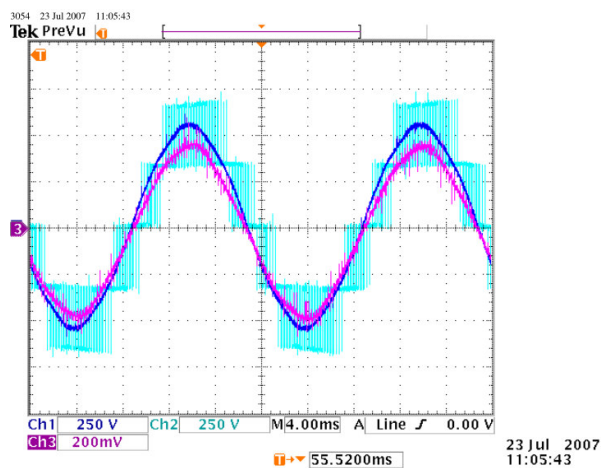

Fig. 8 Steady-state – rectifier mode (load ... $P = 9.3$ kW): Ch1: Trolley voltage U_b , Ch2: Sum of voltages at converters ac terminals u_v , Ch3: Trolley current i_i (10mV/A)

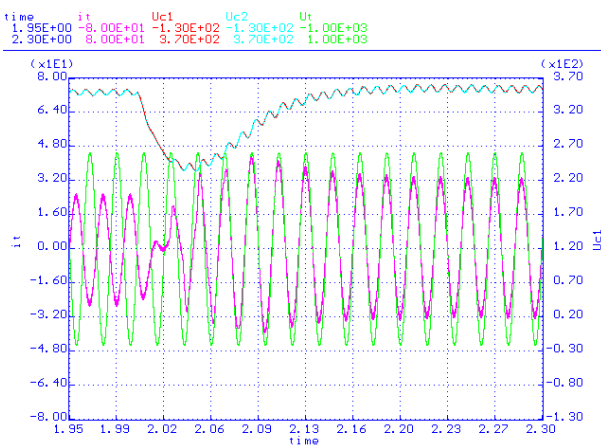

Fig. 9. Transition from inverter to rectifier mode: Step change of the load ... $P = -7.2$ kW \rightarrow 8.8 kW

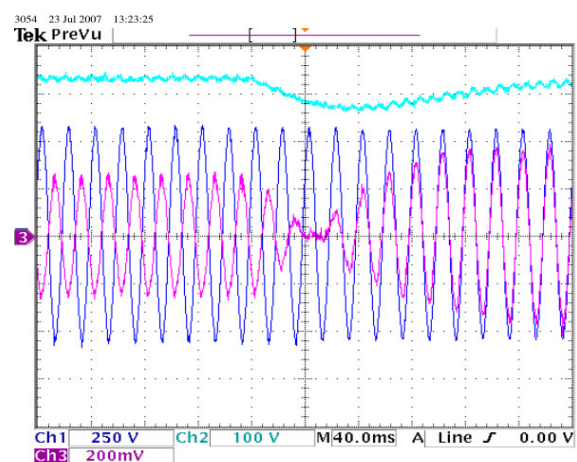

Fig. 10. Transition from inverter to rectifier mode: Step change of the load ... $P = -7.2$ kW \rightarrow 8.8 kW Ch1: Trolley voltage U_b , Ch2: DC-link voltage U_{cl} , Ch3: Trolley current i_i (10mV/A)

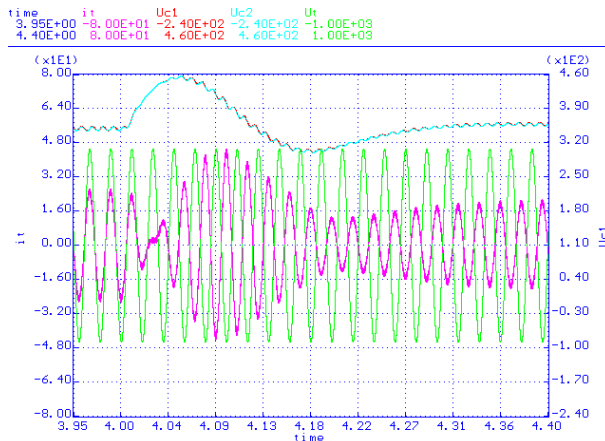

Fig. 11. Transition from rectifier to inverter mode:
Change of the load ... $P = 7 \text{ kW} \rightarrow -5.4 \text{ kW}$

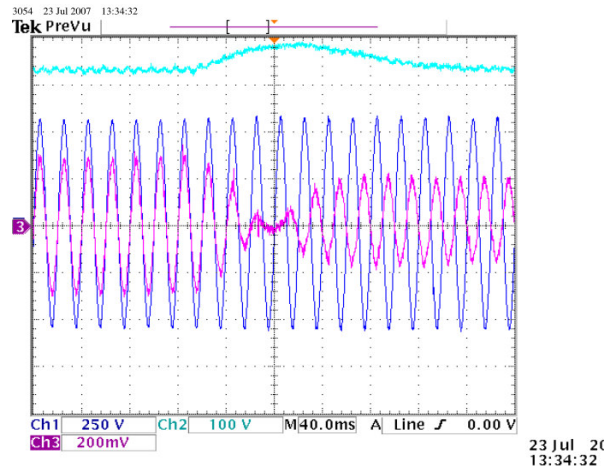

Fig. 12. Transition from rectifier to inverter mode:
Change of the load ... $P = 7 \text{ kW} \rightarrow -5.4 \text{ kW}$
Ch1: Trolley voltage U_b , Ch2: DC-link voltage U_{c1} ,
Ch3: Trolley current i_t (10mV/A)

4. CONCLUSIONS

The presented configuration of the traction converter with medium-frequency transformer is one of the promising solutions for the new generation of the locomotives and especially suburban units. This contribution gives the main emphasis on the control of the primary voltage source active rectifiers, which are directly connected to the ac trolley wire. This paper describes proposed model-based control of primary rectifiers, simulation results under both steady-state and transient conditions and experimental evidence of designed low-voltage laboratory prototype of the locomotive converter with rated power of 12kW. The employed PWM uses shifted carriers, thus, the converter provides multi-level voltage on its input terminals. The operated control as well as PWM are simple for implementation and sufficiently robust. The designed laboratory prototype of traction converter has been successfully tested in the whole power range. We have prepared in cooperation with our industrial partner Škoda Electric, a.s. a 100kW prototype, which is nowadays under the tests.

Acknowledgment

This research has been supported by the Ministry of Industry and Trade of the Czech Republic under the project FT-TA2/035. This project is realized in cooperation with Škoda Electric, a.s., Plzeň, Czech Republic (www.skoda.cz).

REFERENCES

- [1] PEROUTKA, Z., VONDRÁŠEK, F., MOLNÁR, J.: *Traction Converter with Medium-Frequency Transformer: Proposed Converter Control*. Research report no. 22160-22-07. University of West Bohemia in Pilsen, Plzeň, 2007. (in Czech)
- [2] VICTOR, M.: *Energieumwandlung auf AC – Triebfahrzeugen mit Mittelfrequenztransformator*. Fahrzeugtechnik eb 103 (2005) Heft 11, str. 505 - 510.
- [3] STEINER, M., REINOLD, H.: *Medium Frequency Topology in Railway Applications*. In: EPE 2007. Aalborg, Denmark.
- [4] KJELLQVIST, T.; NORRGA, S.; ÖSTLUND, S.: *Design considerations for a Medium Frequency Transformer in a Line Side Power Conversion System*. Annual IEEE Power Electronics Specialists Conference 2004. Aachen, pp. 704-710.
- [5] CARPITA, M.; PELLERIN, M.; HERMINJARD, J.: *Medium Frequency Transformer for Traction Applications making use of Multilevel Converter: Small Scale Prototype Test Results*. SPEEDAM2006, Taormina, pp. S2-17 – S2-22.
- [6] RUFER, A.; SCHIBLI, N.; CHABERT, C.; ZIMMERMANN, C.: *Configurable front-end converters for multicurrent locomotives operated on 16 2/3 Hz AC and 3 kV DC systems*. In: Power Electronics, IEEE Transactions on Volume 18, Issue 5, Sept. 2003 Pages: 1186 – 1193, 10.1109/TPEL.2003.816191.